

1

AREA OF USE

2

SUBSTRATES

3

INSTALLATION

4

FIRST USE

5

MAINTENANCE/GUARANTEE

IMPORTANT

This floor covering is reserved for residential use only and cannot be used in the following cases: verandas, where temperatures can dip below 15°C, reversible floor heating or with temperatures exceeding 28°C, cracked floors, rising damp from the floor, OSB boards.

The installation in front of bay window/skylight is allowed only if the floor temperature never exceeds 28°, or if the floor is protected from direct sunlight by curtains, blinds or other suitable protection.

The use of underlayer is not recommended.

For any additional technical information, please consult a specialist.

IMPORTANT: The information in this document is valid from 31/05/2022 and is subject to change without prior notice. In the face of continuous technical improvements, before starting any work, our customers should check with us that this document is still in force.

SENSO SELF-ADHESIVE URBAN / NATURAL / RUSTIC

1

2

3

4

5

AREA OF USE

SUBSTRATES

INSTALLATION

FIRST USE

MAINTENANCE/GUARANTEE

1. GENERAL

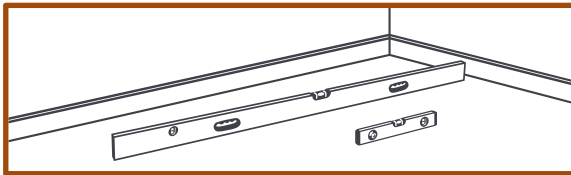

The flooring must be laid on a flat, clean, sound, dry and solid substrate.



The substrate must be dry and must not have any risk of rising damp. Do a control test if necessary.

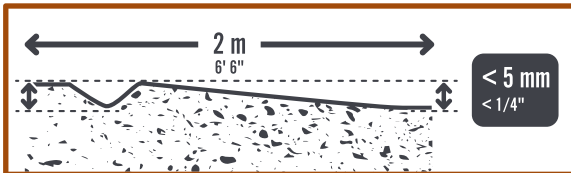

Evenness must be $< 5 \text{ mm}$ under the 2-metre rule.

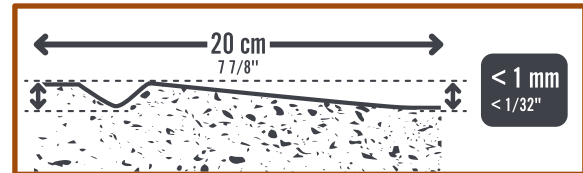

The substrate must not have any uneven areas $> 1 \text{ mm}$ every 20 cm.

2. RECOMMENDATIONS BY SUBSTRATE TYPE

Substrate

Conditions

Substrate	Conditions
Ceramic tiles	✗ Fix the unsealed tiles. Clean. Apply a levelling compound. Sand and apply a primer.
Carpet/Laminate floor	✗ Remove the floor covering and if the floor has many irregularities, apply a patching compound.
OSB floor	✗ Screw a lining board on top.
Underlayer	✗ Remove the underlayer and if the floor has too many irregularities, apply a patching compound.
Underfloor heating	✗ Reversible underfloor heating and underfloor heating $T > 28\text{-C}$.
Compact vinyl floor/soundproof floor/ laminated parquet	✗ Remove the floor covering and any underlayer. If necessary, apply a levelling compound.
Concrete floor, painted concrete, levelling concrete, liquid cement screed	✓ If the moisture content $< 4.5\%$, without cracks. If the floor has too many irregularities, apply a patching compound.
Anhydrite screed	✓ If moisture content $< 0.5\%$. Remove surface laitance and apply a primer for anhydrite screed.
Wood strip flooring and timber panels	✓ Glued wood strip flooring: remove. Flooring on sleepers: fix a lining board.

SENSO SELF-ADHESIVE URBAN / NATURAL / RUSTIC

1

AREA OF USE

2

SUBSTRATES

3

INSTALLATION

4

FIRST USE

5

MAINTENANCE/GUARANTEE

1. BEFORE LAYING

All floor and wall coverings should be examined prior to installation for any visible defects.

To ensure colour uniformity, the floor covering laid in any one room should be from the same manufacturing batch, marked on the packaging.

The room temperature during installation must be between 15°C and 26°C.

The planks or tiles must be unpacked, design side up, in the room 24h before installation.

Clean the surface before laying.



2. TOOLS



Utility knife



Tape measure

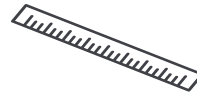

Metal ruler



Cut-resistant gloves

3. LAYING DIRECTION

The planks/tiles must be oriented towards the wall with the main window, or lengthwise.

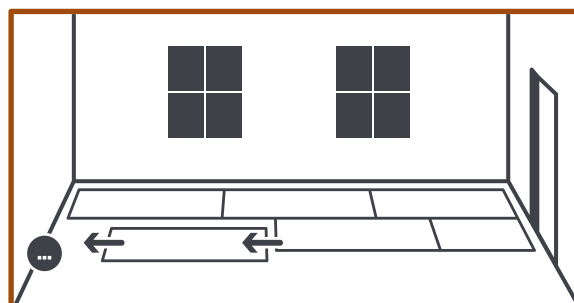

SENSO SELF-ADHESIVE URBAN / NATURAL / RUSTIC

1	2	3	4	5
AREA OF USE	SUBSTRATES	INSTALLATION	FIRST USE	MAINTENANCE/GUARANTEES

4. LAYING OUT THE GUIDELINES

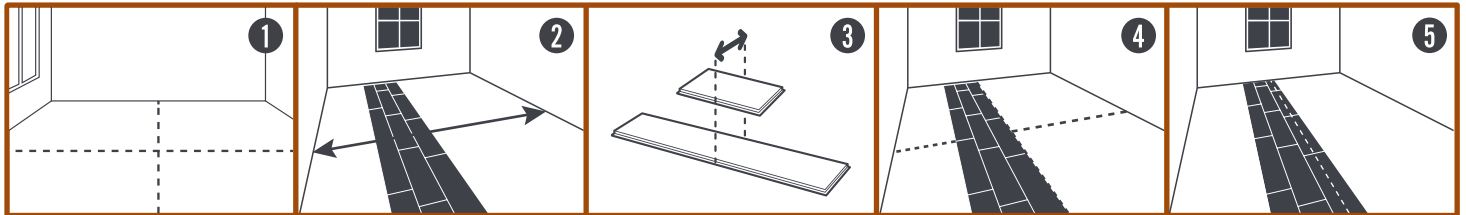

- 1 Divide the room into 4 parts by drawing 2 perpendicular lines intersecting in the centre of the room.
- 2 Measure the side of the room perpendicular to the installation.
- 3 Divide this measurement by the width of the plank/tile. Round up to the next whole number.
- 4 If the number is even, start installation with one plank/tile at either side of the centre line.
- 5 If the number is uneven, start installation with one plank/tile straddling the centre line.

5. PRIMER

www.gerflor.com

The diagram illustrates the primer application process for various substrates. It shows icons for concrete, screed, PVC-LINO-TEXTILE, and LAMINATE OU STRATIFE. Each substrate is shown with a primer bottle and a roller icon, indicating the application process. A circular inset shows a primer bottle and a roller applying primer to a substrate.

SENSO SELF-ADHESIVE URBAN / NATURAL / RUSTIC

1

2

3

4

5

AREA OF USE

SUBSTRATES

INSTALLATION

FIRST USE

MAINTENANCE/GUARANTEE

6. INSTALLATION

A/ Installing planks

- Install the planks on a clean surface.
- Start installing along the longitudinal line.
- Pull off the protective paper.
- Press the plank firmly from the centre outwards.

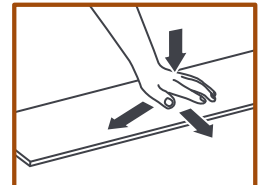
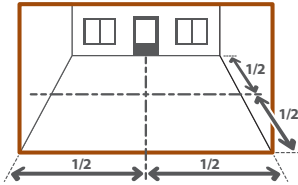

Planks must be offset by at least 25 cm, ideally $\frac{1}{3}$ of the plank.

A maximum edge clearance of 1 to 2 mm should be left around the edge of the room and around fixed objects.

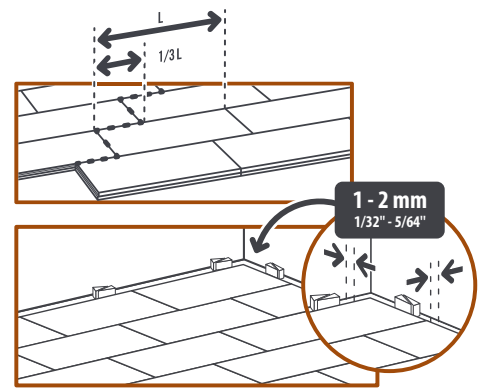

B/ Installing the tiles

- Install the tiles on a clean surface.

- Lay down the tiles in staggered joint along the guidelines on the floor.

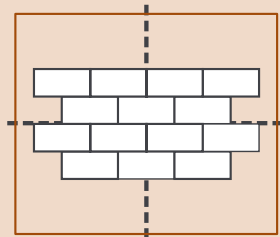

- Check the tile joints for evenness.

Square tiles can also be laid in staggered joint.

- Pull off the protective paper.
- Press the tile firmly from the centre outwards.

A maximum edge clearance of 1 to 2 mm should be left around the edge of the room and around fixed objects.

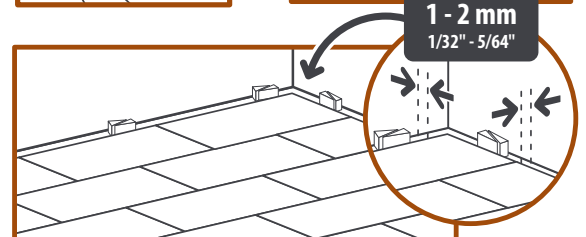
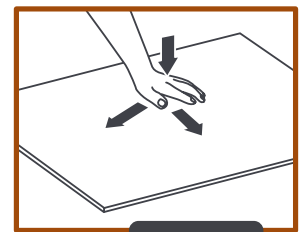

SENSO SELF-ADHESIVE URBAN / NATURAL / RUSTIC

1

2

3

4

5

AREA OF USE

SUBSTRATES

INSTALLATION

FIRST USE

MAINTENANCE/GUARANTEE

7. CUT

For the tiles, even out the cuts on the edges. Cuts are made using a cutter:

- With the straight blade, make one or more cuts along the surface of the plank.
- Bend the plank/tile to snap it.

We recommend applying a PU or MS Polymer sealant along water fittings and along the edge of the room when finishing in wet rooms (bathrooms, toilets).

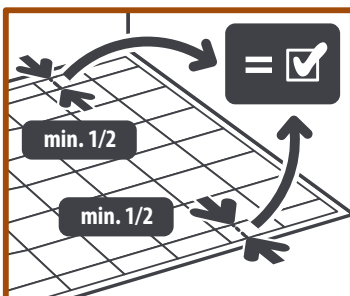
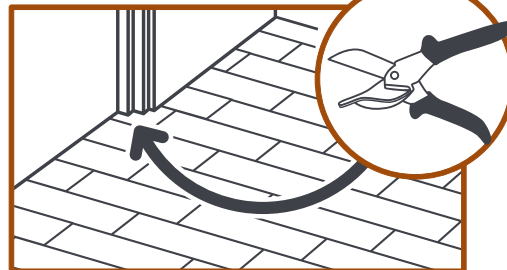
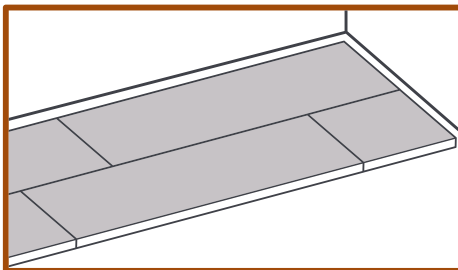
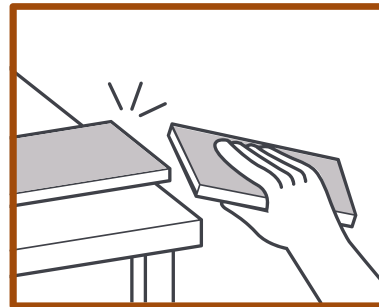
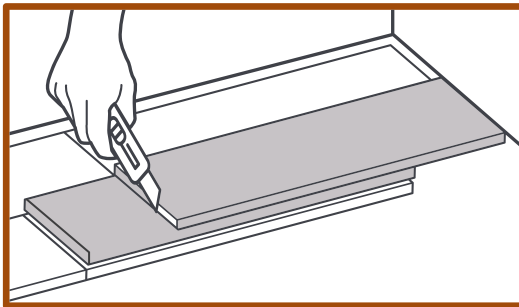

TIP: For cutting around door frame bases and areas which are difficult to access, use gripper shears.

SENSO
SELF-ADHESIVE
URBAN / NATURAL / RUSTIC

1

AREA OF USE

2

SUBSTRATES

3

INSTALLATION

4

FIRST USE

5

MAINTENANCE/GUARANTEE

The flooring can be used **as soon as** it is installed.

Usage precautions: place plastic or felt pads under furniture legs or heavy objects. Protect tiles/planks from heat sources and possible blasts of heat. Do not use rubber end caps (tables, chairs, sofas, etc.), as well as rubber-backed entrance mats.

Use felt caps.

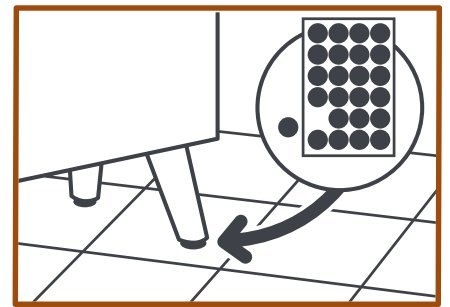
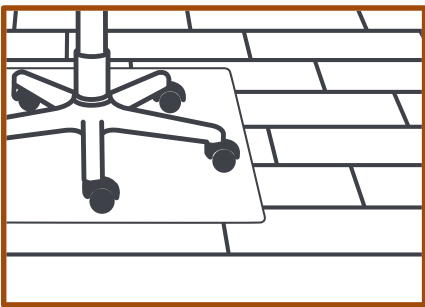

1

AREA OF USE

2

SUBSTRATES

3

INSTALLATION

4

FIRST USE

5

MAINTENANCE/GUARANTEE

Cleaning your floor: vacuum cleaner or damp mop. Regular non-abrasive detergent.

Tough stains: diluted liquid bleach, white spirit, ethyl alcohol, or lemon juice.

Stubborn stains (ink, tomato, mustard, blood, beets, Mercurochrome): let diluted liquid bleach sit for several minutes, without rubbing. Rinse thoroughly. **Rust:** clean using a textile rust remover. Rinse thoroughly.

Grease, pen, felt pen: rub lightly with a cloth soaked in white spirit. Rinse thoroughly.

Maintenance precautions: do not use acetone or chlorinated solvents (e.g. trichloroethylene). Never use waxes or vitrifying varnish.

The Gerflor commercial warranty for domestic products is available on www.gerflor.fr

Replacing a plank/tile:

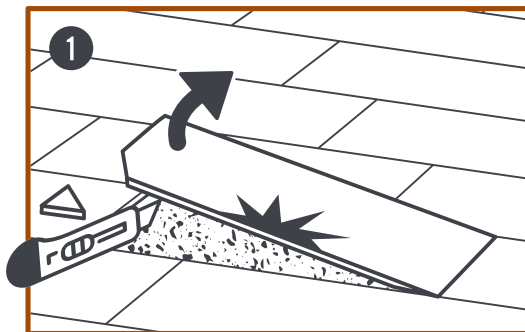

1
 Cut into the corner using the utility knife.
 Remove the plank/tile.

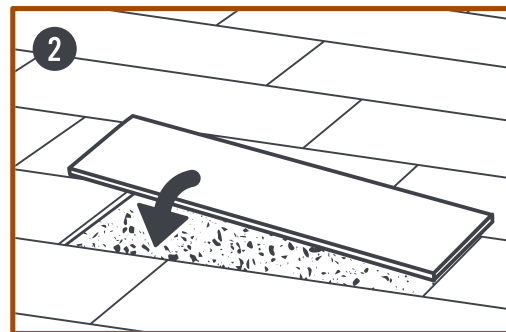

2
 Then reposition a plank/tile and firmly press
 the plank from the centre outwards.

ADDITIONAL INFORMATION:

The joints between tiles/planks may separate – this is part of natural ageing and does not need to be repaired.